

### i15 PARTS LIST







No.	Part No.	Description	Photo
<b>WETTED PARTS (V1 + V2)</b>			
1	11-2330-0	STEM TAIL TEE ¼	
2	11-2970-0	COUPLER MOTOR SPIRAL LEFT	
3	11-2971-0	COUPLER MOTOR SPIRAL RIGHT	
4	11-2974-0	COUPLER BUSHING SPIRAL	
5	11-2980-0	COVER DOOR ICE	
6	11-2981-0	DOOR ICE	
7	11-2987-0	GUIDE ICE FRONT	
8	61-1908-0	EPS PAD LOWER (WHITE)	
9	91-3611-0	ASSY TANK HOT – SUB	
10	91-3612-0	ASSY MANIFOLD FAUCET - SUB	
11	15000V1.5 DRAIN KIT	V1.5 DRAIN KIT	

12	15000 AUGER RINSE RETROFIT	15K AUGER RINSE RETROFIT	
13	41-2058-0	SENSOR ICE FULL LASER - RECEIVE	
14	41-2059-0	SENSOR ICE FULL LASER - SEND	
15	51-0347-1	FILTER 6" SED	
16	61-1839-0	EPS AUGER (LIGHT GRAY)	
17	21-0852-0	BKT AUGER LOWER	
18	31-0721-1	TU ELBOW AIR VENT	
19	41-1171-1	SENSOR LEVEL DETECTOR 1PIN BOTTOM	
20	41-1194-2	VALVE SOLENOID HIGH PRESSURE	
21	41-1405-0	PUMP DRAIN	

22	41-1432-2	SENSOR LEVEL DETECTOR 2PIN TOP	
23	11-2330-0	STEM TAIL TEE ¼	
24	21-0848-0	CUTTER AUGER	
25	21-0851-0	BKT AUGER UPPER	
26	11-3048-0	TUBING ¼" 330MM (BLUE)	
27	21-0892-0	WRENCH BOLT	
28	21-0893-0	WASHER	
29	31-0025-1	TUBE END ½"	
30	31-0325-1	SEAL SENSOR LEVEL COLD	
31	31-0422-0	SEAL DOOR ICE	
32	91-3619-0	ASSY TUBING 3/8 PE-RT - SUB	

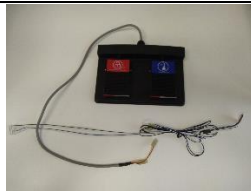
33	91-3698-0	ASSY DOOR ICE	
34	11-3099-0	LINK DOOR ICE	
35	41-1550-0	STERILIZER UV LED TANK	
36	41-1768-4	VALVE SOLENOID 1WAY	
36.1	21-0867-0	AUGER	
37	21-0868-1	TANK HOT	
38	41-1795-0	SENSOR LEVEL DETECTOR -ICE TANK	
39	31-0431-0	CAP DRAIN (BLACK)	

40	31-0577-1	SEALING LEVEL SENSOR	
41	61-1835-0	EPS UNIT (LIGHT GRAY)	
<b>ELECTRONIC PARTS (V1 + V2)</b>			
42	11-2824-0	DECO DISPENSER LIGHT	
43	41-2048-0	POWER CORD PLUG B	
44	41-2064-0	SENSOR TEMPERATURE (TANK)	
45	91-3608-0	ASSY MOTOR GEARED - SUB	
46	41-0308-0	SENSOR TEMPERATURE (EVA)	
47	41-1285-0	MOTOR GEARED (DOOR)	
48	41-1911-1	MOTOR - ICE DISPENSE	

49	41-2018-0	TRANSFORMER	
50	41-2046-0	PCB MAIN	
<b>HANDS-FREE PARTS (V1 + V2)</b>			
51	ADS	AMBIENT DISPENSE STICKER	
52	CDS	COLD DISPENSE STICKER	
53	FOOT SWITCH XF-1D	2 PEDAL SYSTEM	
54	IDS	ICE DISPENSE STICKER	
55	WS150002PDLKIT	15000 ICE AND COLD PEDAL	
<b>PANELS (V1 + V2)</b>			
56	4419	WS 15000 STAND - PWS	
57	11-2964-1	15000 - COVER TOP	
58	21-0853-0	15000 - FRAME SIDE	
59	21-0854-0	15000 - FRAME REAR	

60	21-0860-0	15000 - COVER PCB UPPER	
61	21-0873-0	15000 - COVER RIGHT	
62	21-0874-0	15000 - COVER LEFT	
63	WS 15000 STAND	WS 15000 STAND	
64	91-3622-0	15000 - ASSY PLATE MIDDLE - SUB	
<b>OTHER (V1 + V2)</b>			
65	91-3646-0	15000 - ASSY DECO FAUCET (BLACK)	
66	11-3111-0	15000 - DECO DISPENSER (BLACK)	
67	91-3703-0	15000 - ASSY COVER FRONT - WELLSYS	
68	91-3703-0	15000 - ASSY COVER FRONT - WELLSYS	
69	91-2922-0	PWS OF AMERICA FACEPLATE	

70	91-3592-0	15000 - ASSY PLATE BASE - SUB	
71	91-3607-0	15000 - ASSY UNIT - SUB	
72	91-3614-0	15000 - ASSY TRAY	
73	91-3620-0	15000 - ASSY COVER REAR - SUB	
<b>REFRIGERATION (V1 + V2)</b>			
74	91-3616-0	15000 - ASSY PARTIAL CONDENSER - SUB	
75	21-0864-0	15000 - COMPRESSOR	
<b>WETTED PARTS (V2 ONLY)</b>			
76	41-2209-0	DISPENSE PUMP	
77	11-3436-0	TUBING 1/4 45mm (BLUE)	
78	41-2207-0	ICE MELT PUMP	
<b>ELECTRONIC PARTS (V2 ONLY)</b>			
79	41-2046-5	15000 V2.3 CIRCUIT BOARD	



**i15 WATER FLOW DIAGRAM**

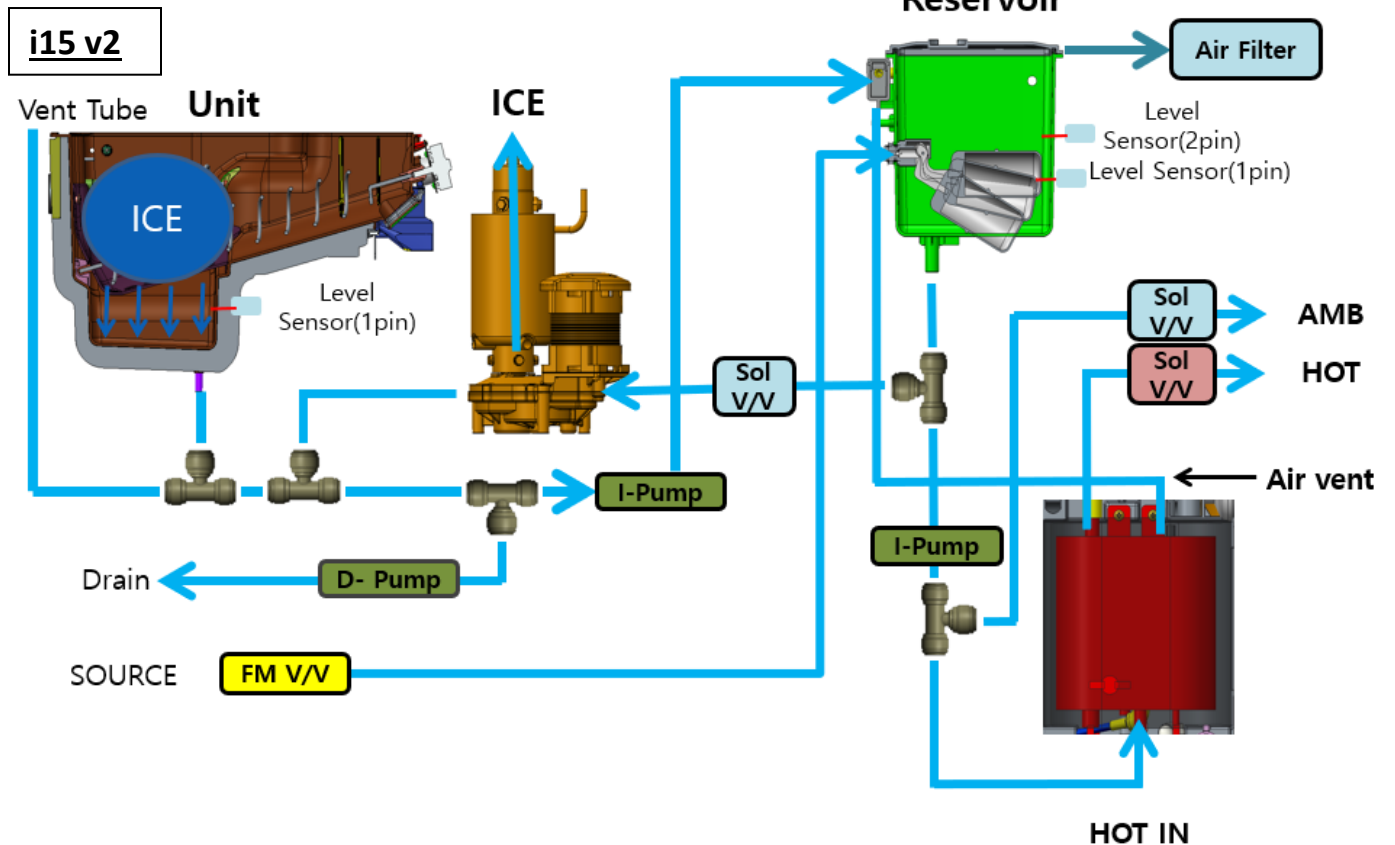
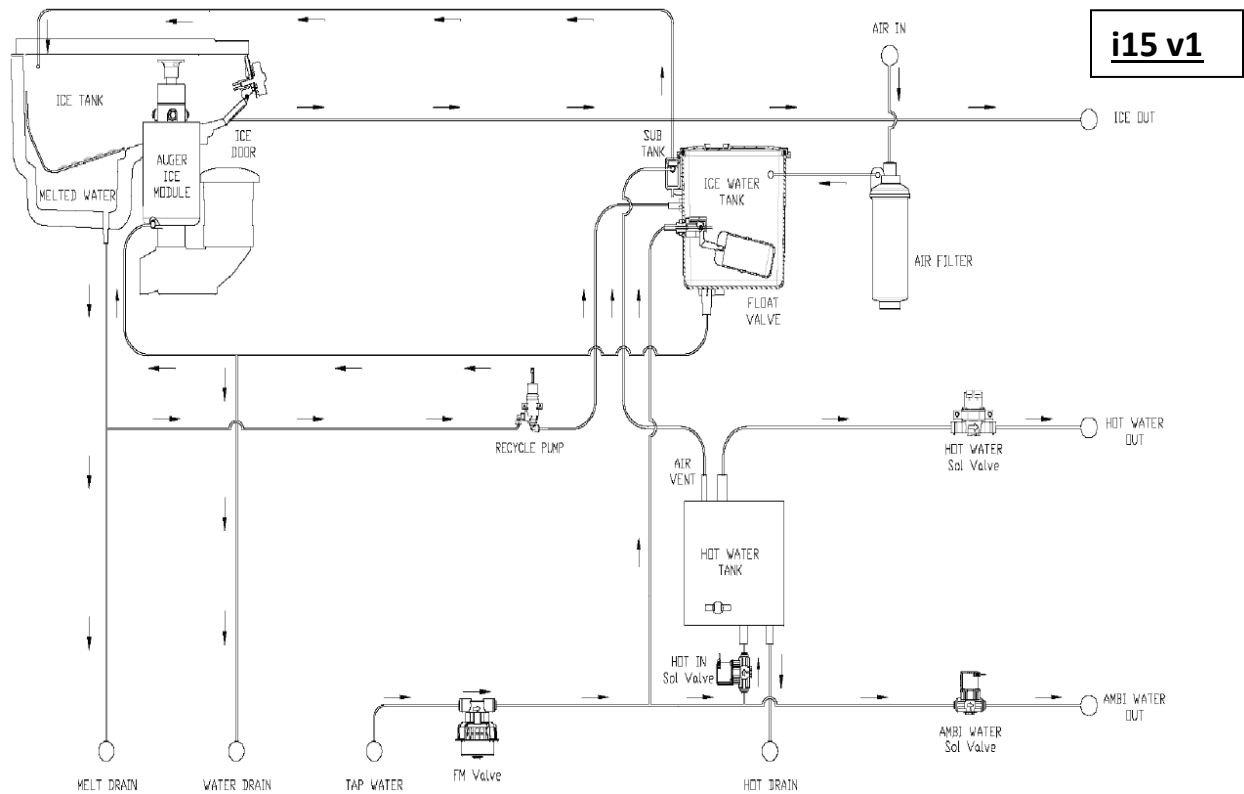

## i15 ELECTRICAL DIAGRAM

**⚠ DANGER!** HIGH VOLTAGE ELECTRICAL HAZARD. PCB (Printed Circuit Board) contains High Voltage. Only trained and qualified technicians should attempt live testing.

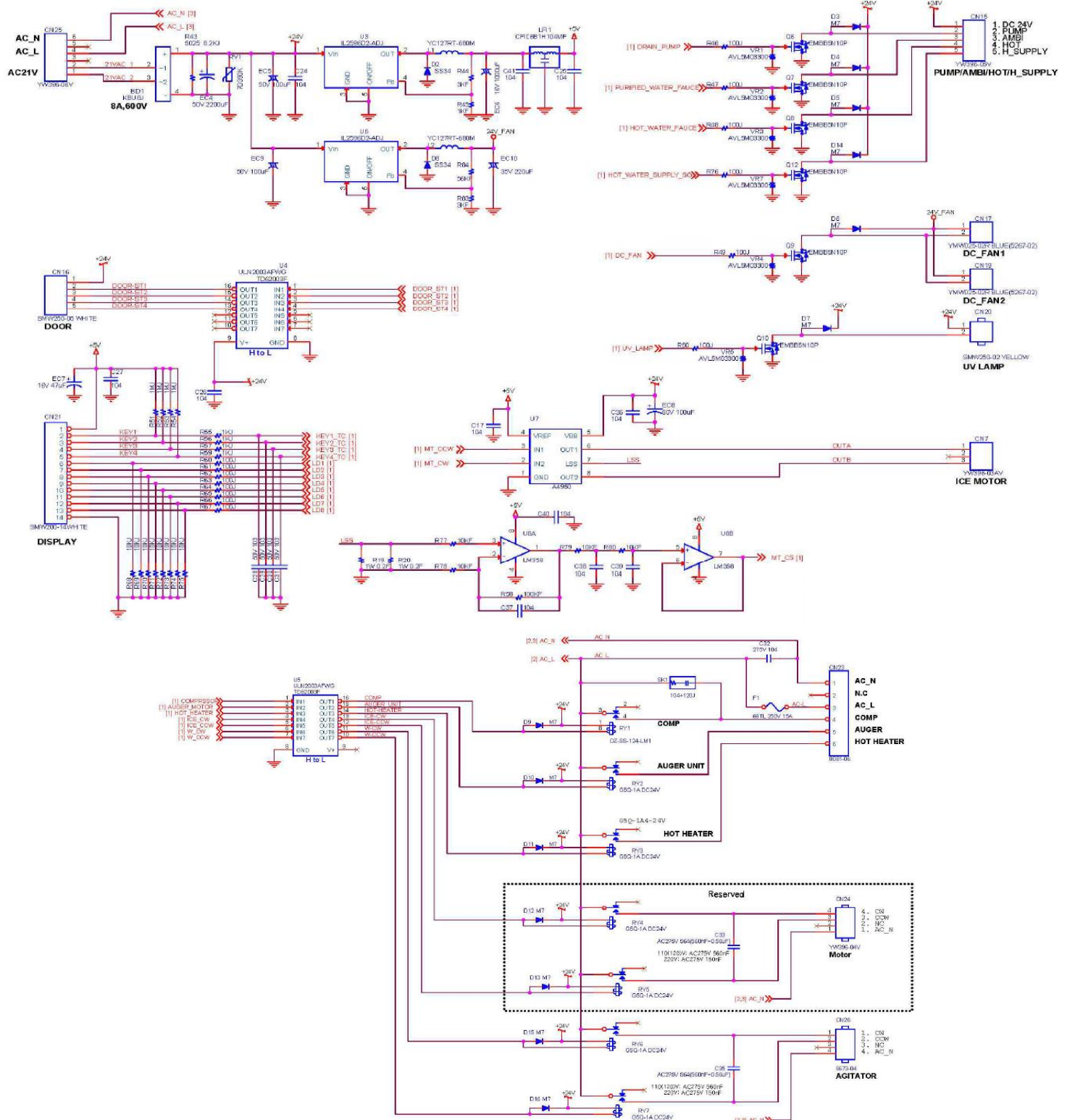

**i15 PCB DIAGRAM**

